

LC 300

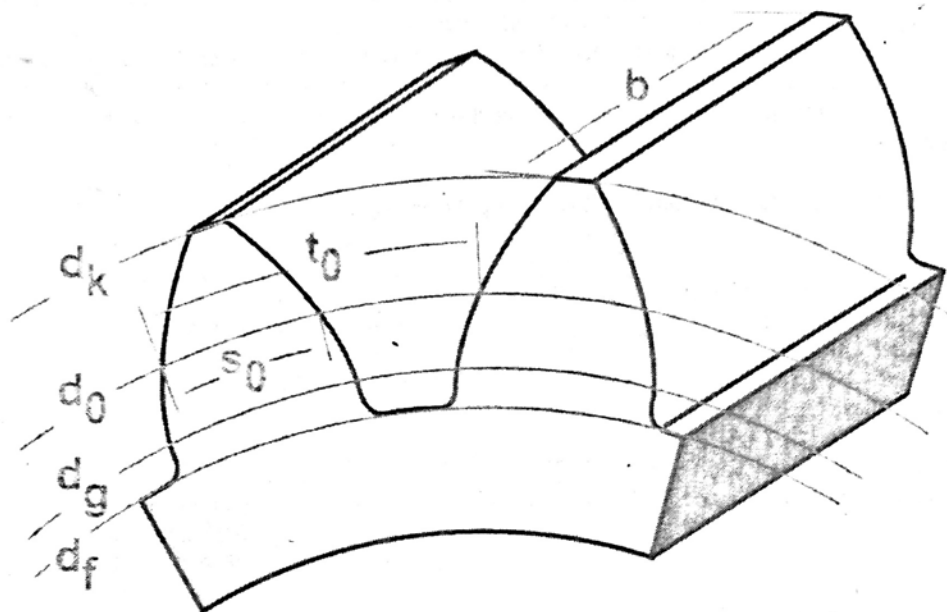

Manufacturer: LIEBHERR VERZAHNTECHNIK GMBH

Machine type: LC 300

Serial number: FN 1704

LIEBHERR

1
2
3
4
5
6

1.0 Packing

The machine/equipment will be shipped either packed or unpacked depending on the contractual agreements. The transport route is also decisive for the type of packaging used. Unless otherwise agreed, the type of packaging will comply with the packaging instructions HPE specified by the Federal Association for Wood Packaging Means, Pallets, Export Packing (Bundesverband Holzmittel, Paletten, Exportverpackungen e.V.) and the Federal Association of Mechanical Engineering Establishments (Verein Deutscher Maschinenbauanstalten). The signs and notes marked on the packing must always be observed.

Explanation of Signs



THIS END UP



FRAGILE



KEEP DRY

PROTECT FROM
HEAT

CENTER OF GRAVITY



SLING HERE

Scope of Disassembly Work

The scope of disassembly work depends on the type and size of machine and equipment, the transport conditions, the local situation and the lifting equipment available.

Care / Handling

LIEBHERR HIGH-PERFORMANCE GEAR CUTTING MACHINES are high-precision machines and must be handled with utmost care during transportation. Shocks and vibrations affect the precision of the machines and must be avoided.

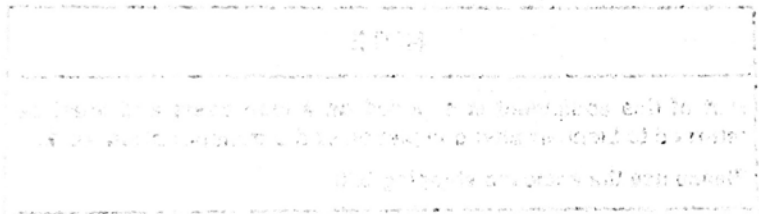

2
3
4
5
6

Handling Information

 DANGER
Never step beneath suspended loads! Use faultless ropes and chains only! Observe load-bearing capacity of the crane! Observe weight information in the shipping documents!

Suspend machine or components only as shown in the illustrations and handle with care.

Handling Equipment

In order to transport the machine, the following equipment is supplied free of charge:

- 1 lifting beam or cross beam
- 2 or 4 lifting eyebolts

NOTE
Part of this equipment is supplied on a loan basis and must be returned to Liebherr after completion of the transportation work! Please use the enclosed shipping bill!

Damage in Transit

Damages in transit must be reported to the carrier or to Liebherr Verzahntechnik in writing immediately!

Intermediate Storage

If the machine/equipment is not installed and assembled immediately upon delivery, it must be stored in a protected area and covered suitably to keep it free from dust and moisture, especially when in unpacked condition. Outdoor storage without approved special protective packing is prohibited.

2

3

4

5

6

Installation

Normally the machine/equipment will be transported to and installed on a suitably prepared site.

Site Conditions

The shop floor must have **sufficient bearing capacity**.

Make sure that the surface the machine is installed on is free of unevenness.

Ensure free access to the control cabinet.

All units on the machine must be accessible.

Ensure sufficient **freedom of movement** for operators and maintenance personnel.

Provide for good **light conditions** on the site.

The type of installation and attachment used is shown on the layout plan of these operating instructions. Floating installation on vibration-damping levelling elements is well-proved. However, the machine may also be attached to the floor by means of tie bolts or dowel bolts.

If fasteners are included in the scope of delivery, please see installation instructions following the layout plan.

1.1 Transportation of a gear cutting machine with external automation

The transportation instruction applies to the following machines:

Module type (BK) 1 (LC 80 - LC 180)

Module type (BK) 2 (LC 200 - 380 resp. LCS 180 - 300)

Transportation equipment

We provide you the following transportation equipments depending on machine type at delivery of the machine:

- Transportation seesaws with chains



Fig. 1 BK1 und BK 2

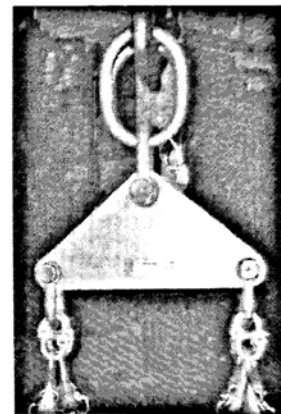

Fig. 2 only BK 1

- 4 Rope screws



Fig. 3 Rope screws

1.1 Transportation of a gear cutting machine with external automation

NOTE

The transportation equipment is only a loan.
It must be returned after completion of the transportation work to the following address:

LIEBHERR Verzahntechnik GmbH
Kaufbeurer Str. 141
D-87437 Kempten (Allgäu)
Abt. Versand

Damages during Transit

Damages in transit notifying the forwarding agent or the contact person at Liebherr Verzahntechnik immediately.

General Notes

You can the respective machine type (LC ...) gather from the delivering papers or the description on the machine.

It has to be taken care at the transportation that all transport locks are attached (red painted).

NOTE

The belt eyes attached at the machine bed at the side (see figure 4) aren't designed for raising the machine!

They only for the protecting of the machine on the truck.

Belt eyes

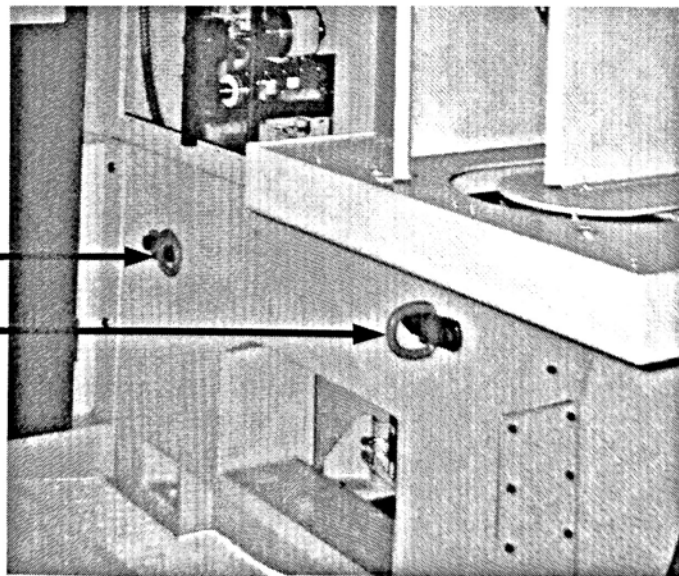

Fig. 4 Belt eyes

1.1 Transportation of a gear cutting machine with external automation

Depending on equipment and type of the machine we suggested different transportation-proceeded or transportation equipments.

Gear cutting machine (BK1 and BK2) with external automation (Variant 1)

At these machines the automation (conveyor etc.) is provided and is transported separately.

The control cabinet is fastened to the machine bed with a transport lock and is put at the on putting place onto the ground.

Gear cutting machine (BK1 and BK2) with external automation (Variant 2)

At these machines the automation (conveyor etc.) is provided and is transported separately.

The control cabinet gets up on supports connectedly to the machine bed and remains at the on putting place on this.

2
3
4
5
6

1.1 Transportation of a gear cutting machine with external automation

**Gear cutting machine
(BK1 and BK2) with
external automation
(Variant 1)**

The roof and side shields of the machine housing are disassembled.
Mount the 4 rope screws into machine bed in the appropriate places.

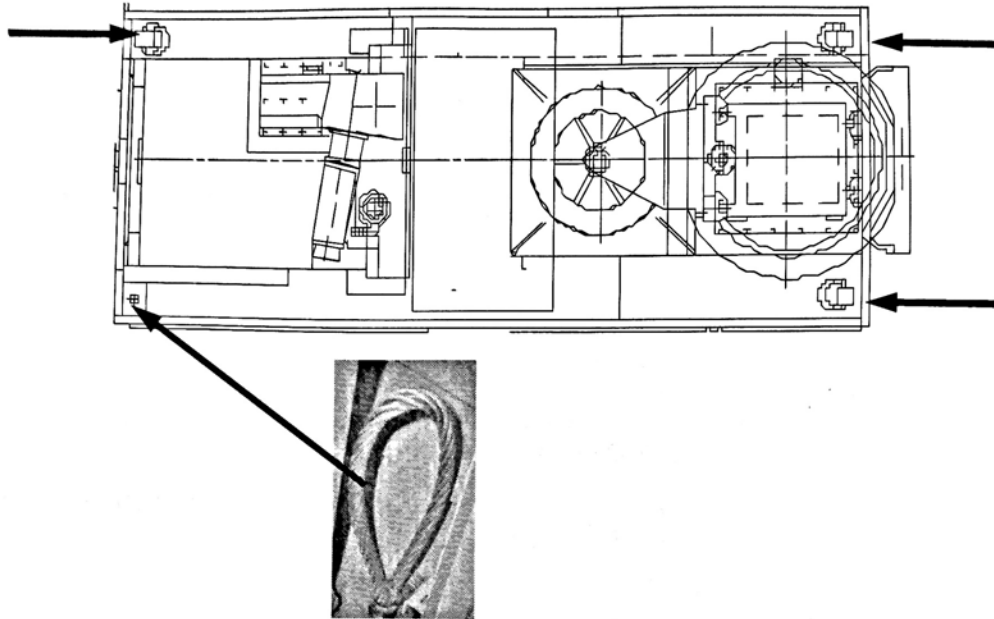

Fig. 5

The chains and fastening bolts of the enclosed transportation device are already adjusted correctly in most cases.



Fig. 6 Transport seesaws

1.1 Transportation of a gear cutting machine with external automation

Appending the transportation device to a crane with sufficient load bearing capacity.

⚠ DANGER

Make sure that the transportation device is fastened to the crane tightly!

Make sure that the rope screws are screwed tightly in machine bed!

Make sure that the chain hooks are tightly sit in the rope screws and the chain hook protection is closed!

Make sure that the length of the chains are so adjusted that the machine hangs horizontally!

Make sure that the chains do not touch the machine or parts of the machine!

Never stand at the transportation under the machine!

The load bearing capacity of the crane has to be taken into account!

Weight of the machines:

BK1 up to 12000 kg
BK2 up to 18000 kg
The exact weight you find in the so-called "packing list"!

Transporting the machine to the desired place.

If the machine is placed on a oil collecting plate (optionally) this must be put correctly before the machine is sit down.

In rule the machine is put on so-called "leveling elements" which must be fastened to the bottom of the machine bed.

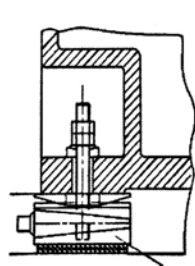

leveling elements

Fig. 7

1.1 Transportation of a gear cutting machine with external automation

! DANGER

Work at or under the raised, unsecured machine (suspended load) is forbidden!

Is work under the lifted machine inevitably, like e. g. the assembly of the leveling out elements then security procedures must taken. The machine must be protected with eloquently high under laying woods (hardwood) or steel blocks.

Now the control cabinet must be dismantled and put onto the ground:

! DANGER

The control cabinet must be fastened to the crane before the transport locks dismantled !

Mount the transportation eyes at the control cabinet and fastening the chains on it.

Observe the load-carrying capacity of the crane

Weight of the control cabinet: 1000 kg

Stretching the chains with the crane.

Making sure that the control cabinet doesn't fall when solving the transport locks.

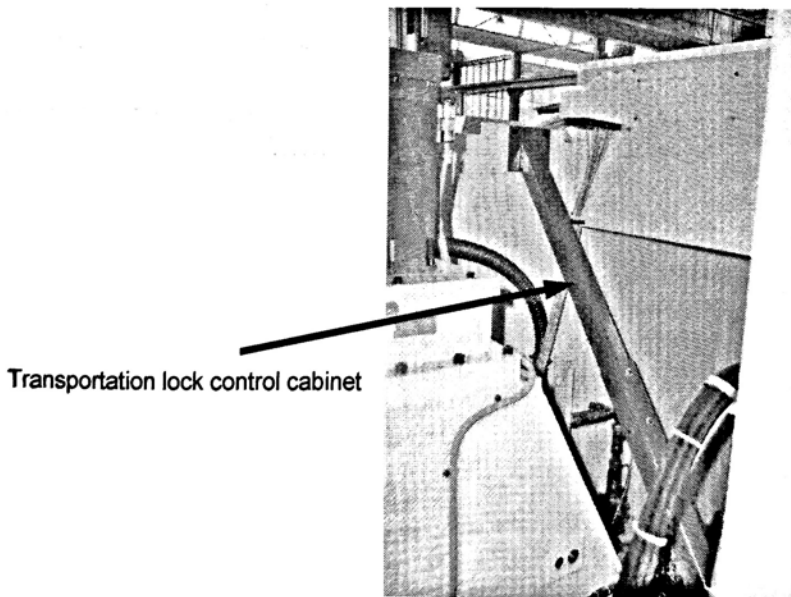

Fig. 8

Transportation locks at the floor of the control cabinet.

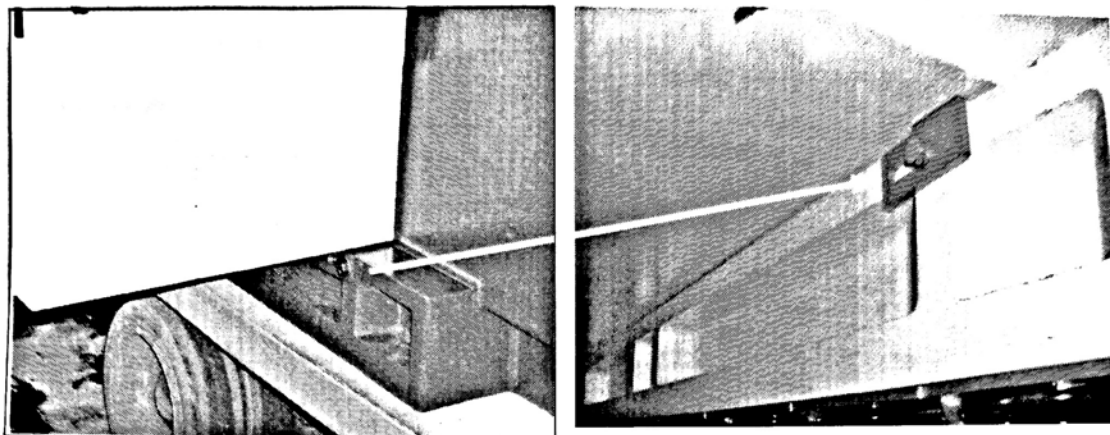

Fig. 9

NOTE

The connection wires must be paid attention that at transporting of the control cabinet these aren't broken off!

1.1 Transportation of a gear cutting machine with external automation

Control cabinet sit beside the machine BK1 and BK2

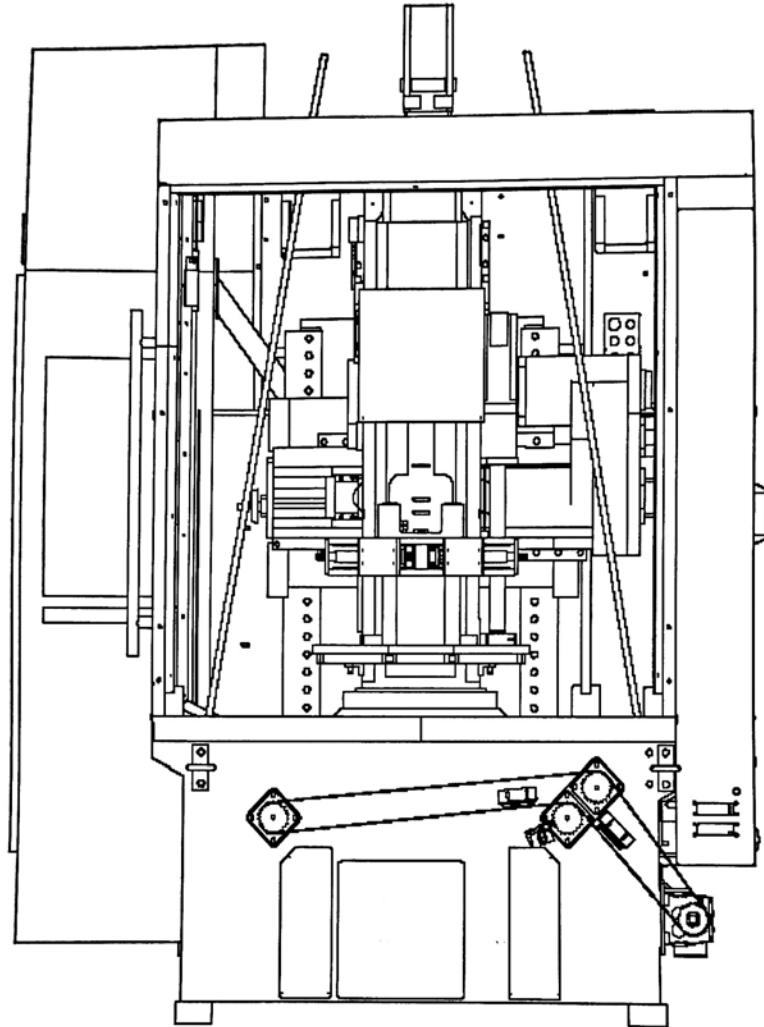

Fig. 10

**Gear cutting machine
(BK1 and BK2) with
external automation
(Variant 2)**

The roof and side shields of the machine housing are disassembled.
Mount the 4 rope screws into machine bed in the appropriate places.

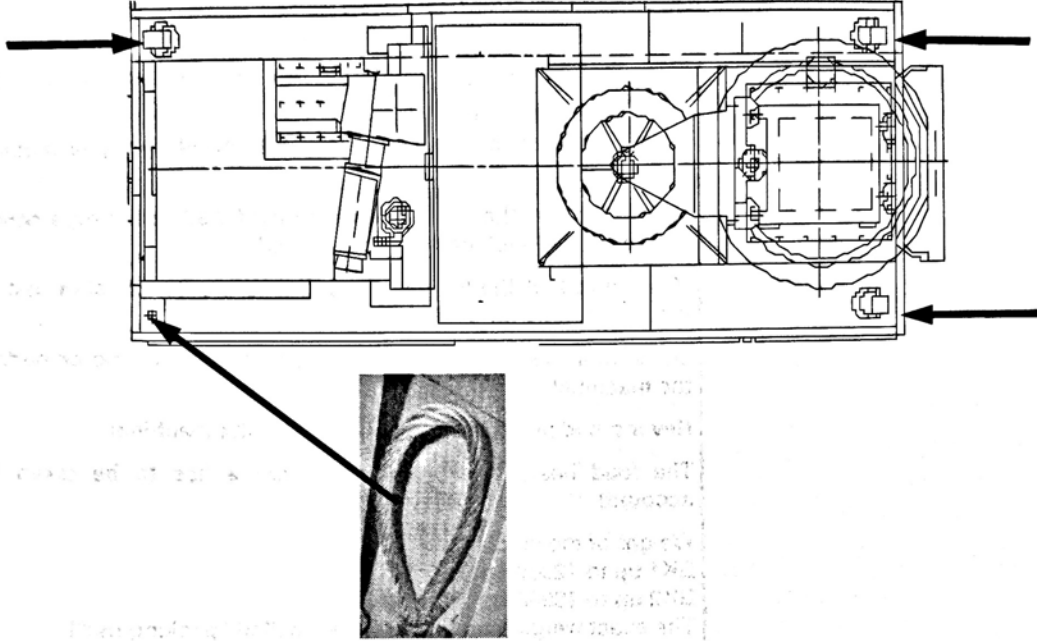

Fig. 11

The chains and fastening bolts of the enclosed transportation device are already adjusted correctly in most cases.



Fig. 12

1.1 Transportation of a gear cutting machine with external automation

Appending the transportation device to a crane with sufficient load bearing capacity.

⚠ DANGER

Make sure that the transportation device is fastened to the crane tightly!

Make sure that the rope screws are screwed tightly in machine bed!

Make sure that the chain hooks are tightly sit in the rope screws and the chain hook protection is closed!

Make sure that the length of the chains are so adjusted that the machine hangs horizontally!

Make sure that the chains do not touch the machine or parts of the machine!

Never stand at the transportation under the machine!

The load bearing capacity of the crane has to be taken into account!

Weight of the machines:
BK1 up to 12000 kg
BK2 up to 18000 kg
The exact weight you find in the so-called "packing list"!

Transporting the machine to the desired place.

If the machine is placed on a oil collecting plate (optionally) this must be put correctly before the machine is sit down.

In rule the machine is put on so-called "leveling elements" which must be fastened to the bottom of the machine bed.

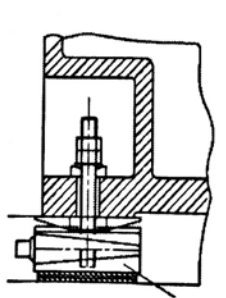

leveling element

 **DANGER**

Work at or under the raised, unsecured machine (suspended load) is forbidden!

Is work under the lifted machine inevitably, like e. g. the assembly of the leveling out elements then security procedures must taken. The machine must be protected with eloquently high under laying woods (hardwood) or steel blocks.

1.1 Transportation of a gear cutting machine with external automation

Control cabinet is mounted on the machine bed BK 1 and BK2

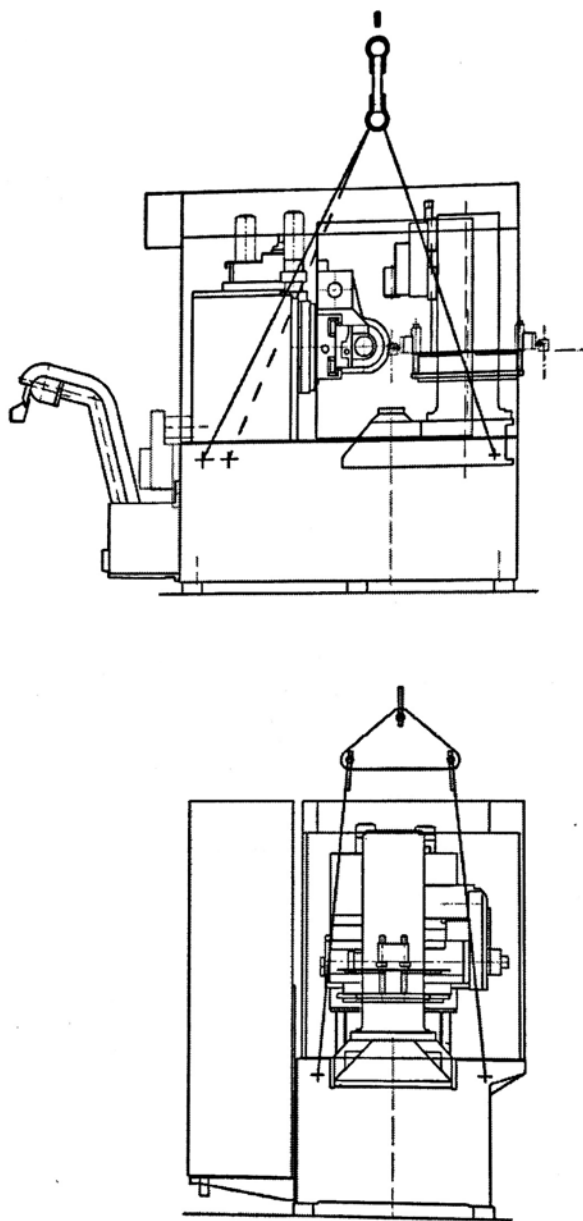









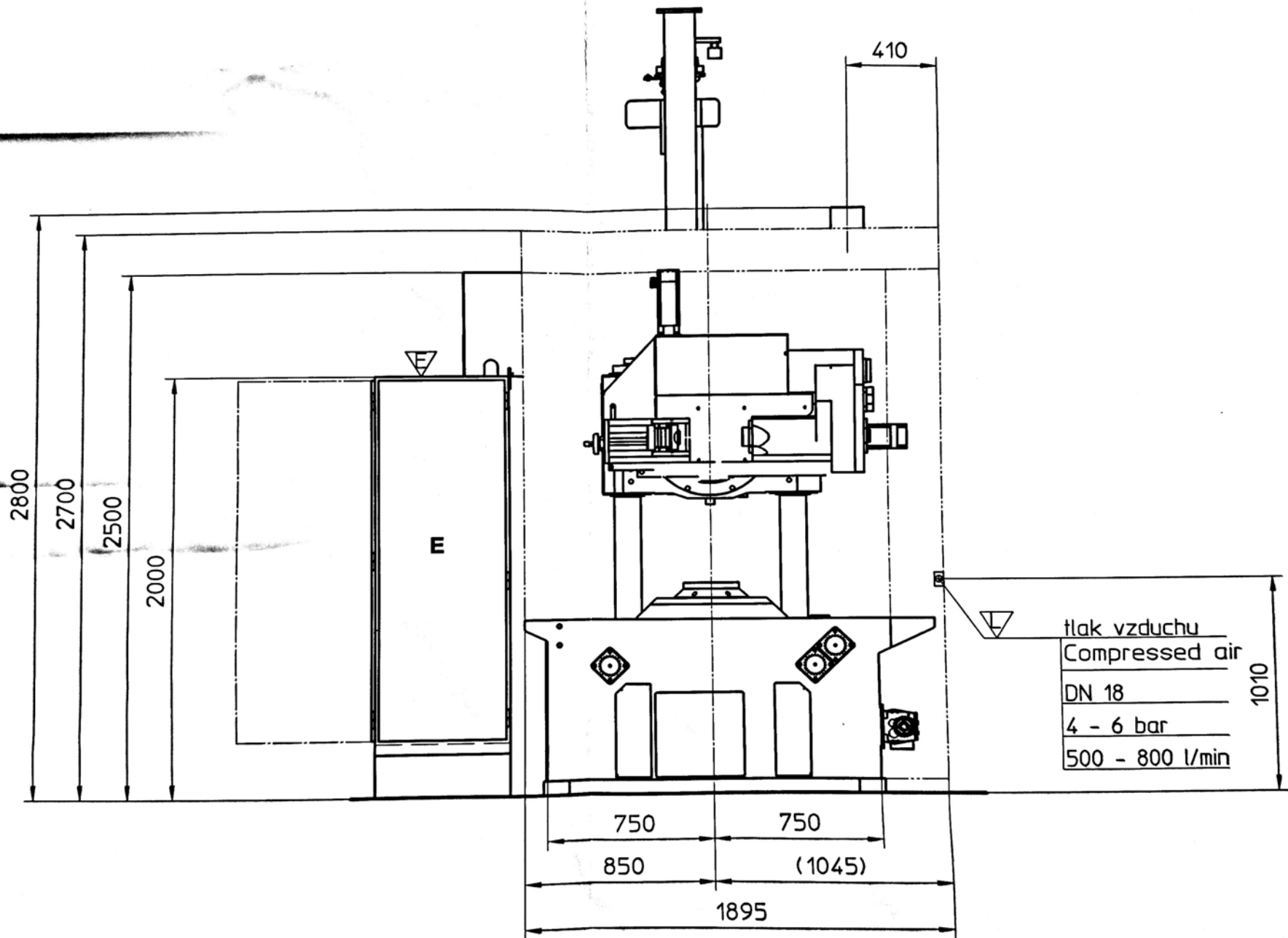
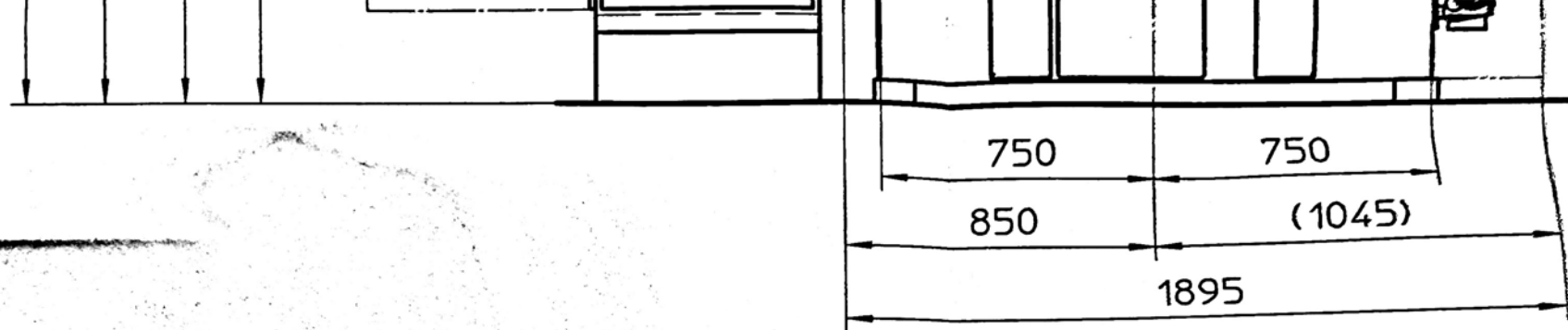

Fig. 13

1.2 Layout and foundation plan

	Operating station
	Location of main power supply
	Connection for coolant fluid Center in flow direction
	Junction for compressed air
E	Electric cabinet
H	Hydraulic unit
S	Lubrication unit
C	Recooling unit
-----	Required space
	Directional symbol
	Attention voltage
	Anchor bolt
	Levelling screw
CH	Chip conveyor
D	Oil mist separator
K	Chip retainer
T	Transformer
OKF	Upper edge base
UKM	Lower edge machine
B 	Loading height
E 	Unloading height





E

D

C

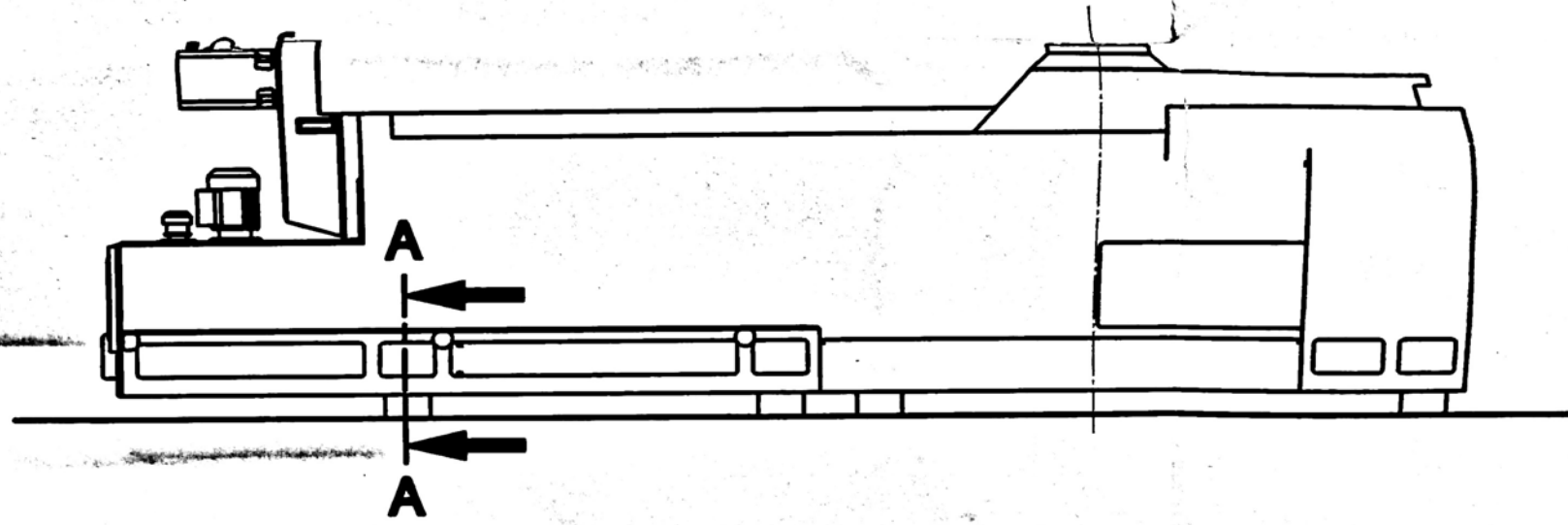

3395

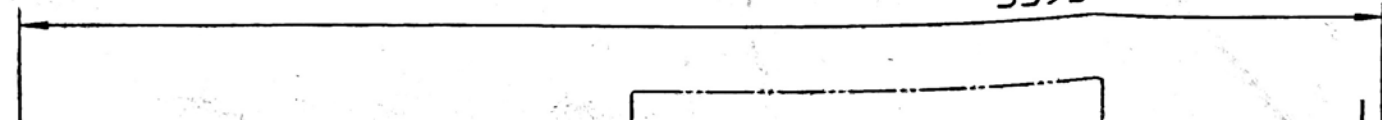

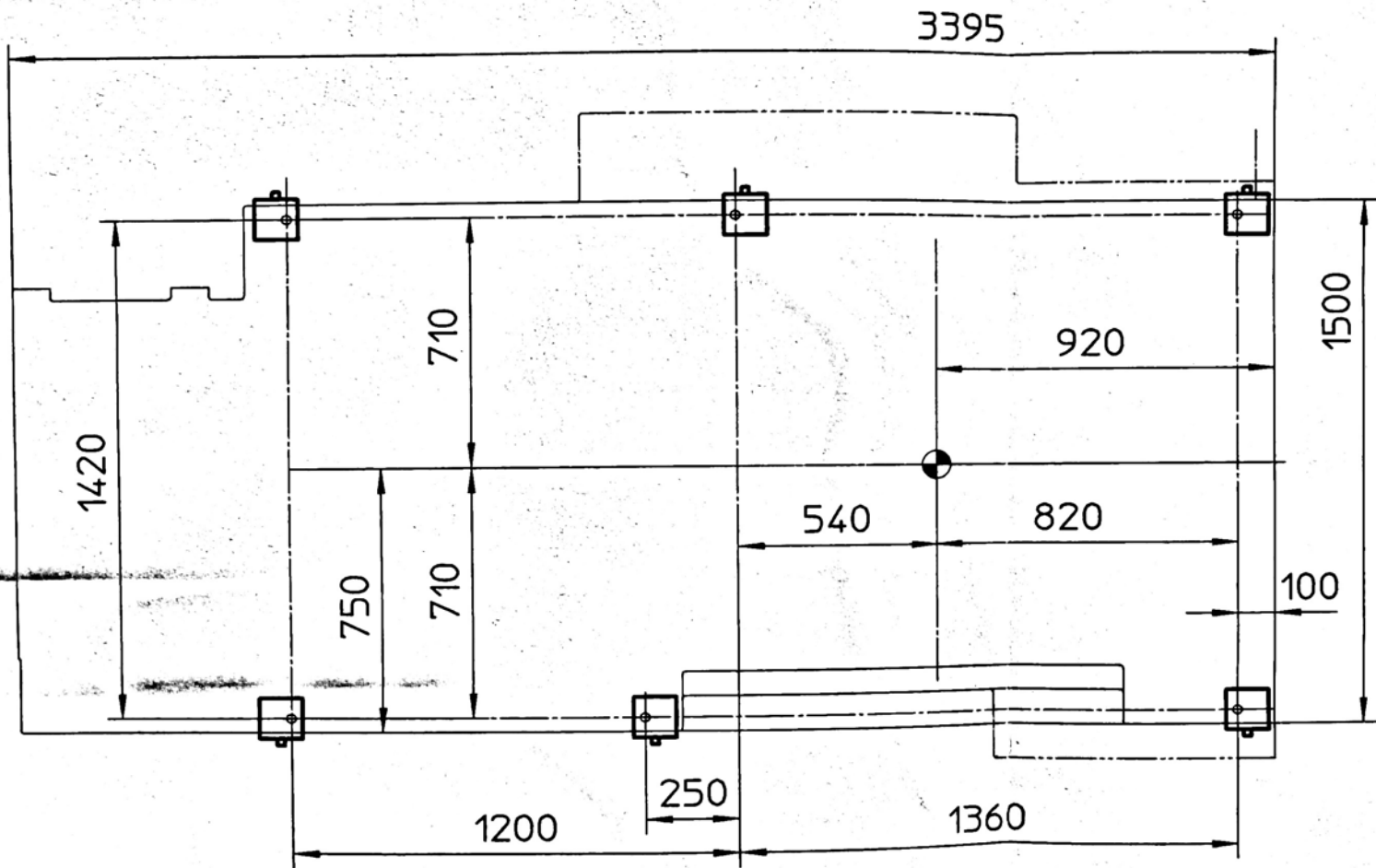

pohled na stranu obsluhy bez skrínoveho rozvadece
View on oper.side without ctrl.cabinet

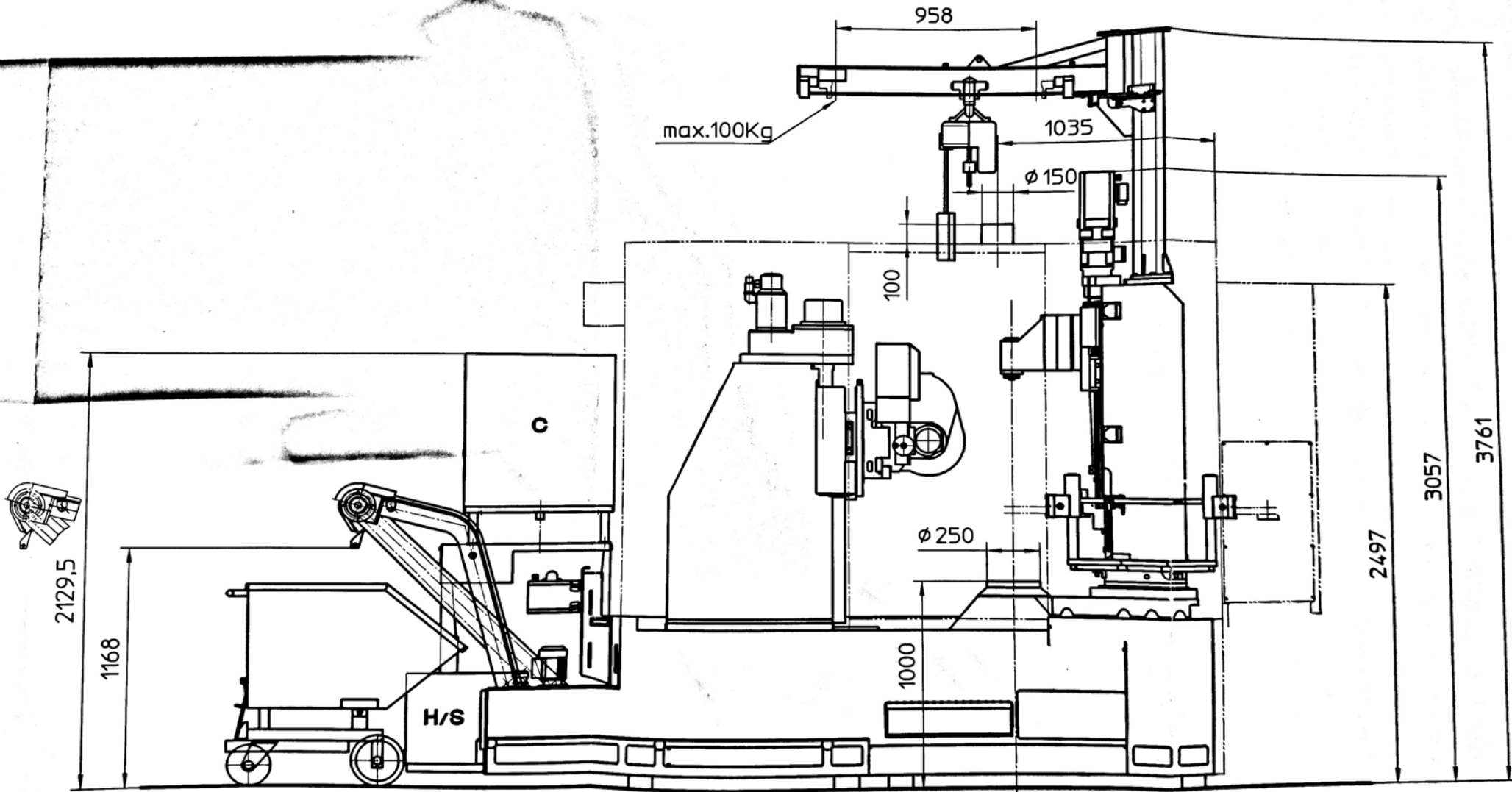

6133

4294,5

940

1850

970

480

790

545

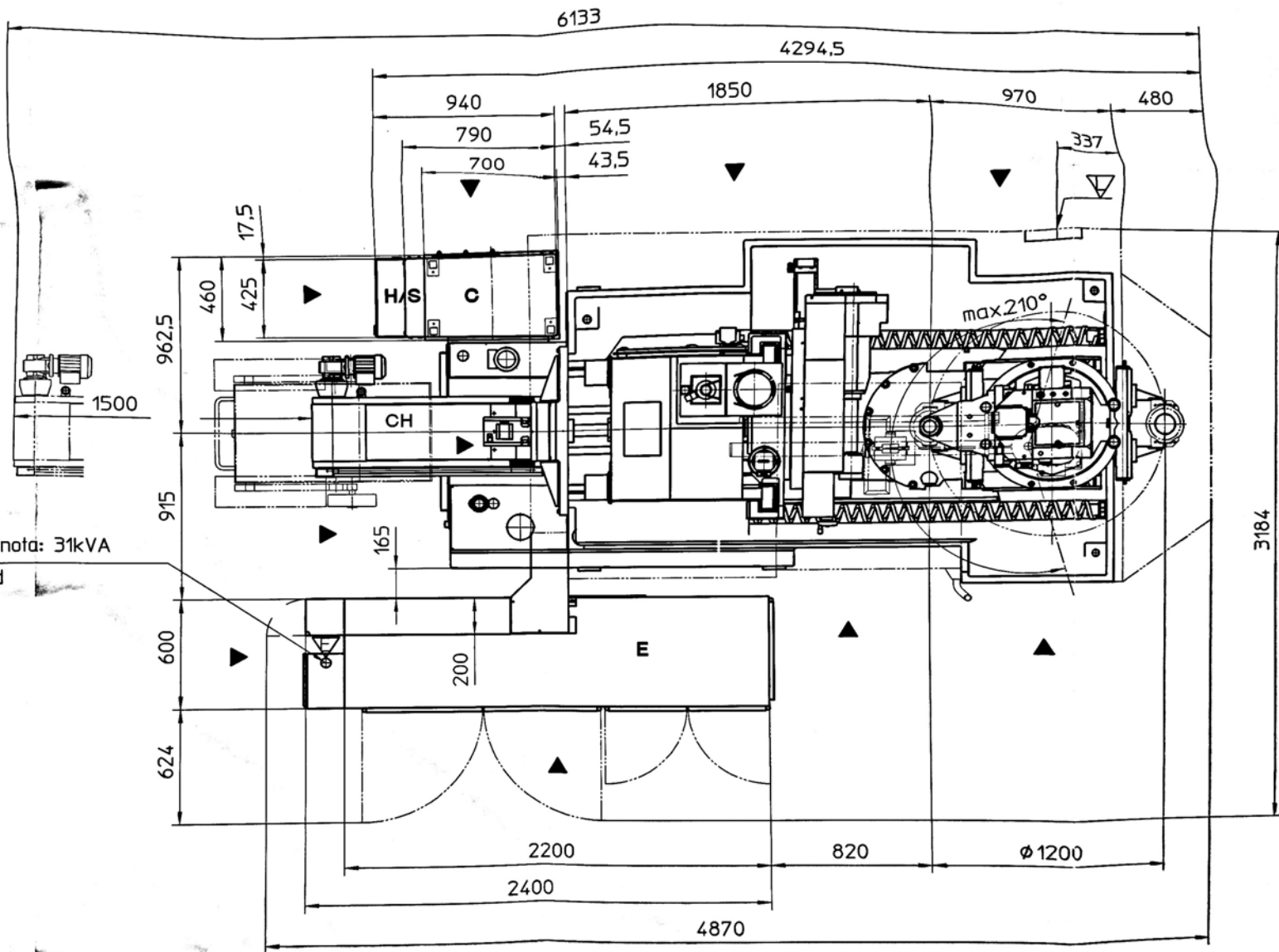

celková prípojná hodnota: 31kVA
Total connected load

A-A
M 1:5

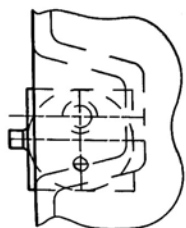
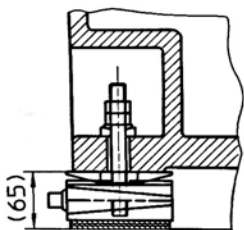

FN Nr. 1650/1704 HMC CZ

vyrobní číslo
Serial number

hmotno
Mach

c	Tschechische Texte anstatt deut
b	ELB-Box hinzu
a	Gesamtanschlusswert wurde von
ÄNDERUNGEN MODIFICATIONS	
MASSTAB SCALE	GEZ. DRAWN
1:20	26.02.07
GEPR. CHECKED	30.04.08
BENENNUNG DESCRIPTION	
AUFSTELLPLAN MONTĚŽNÍ VYKRES - INSTALLA	

ALLGEMEINTOLERANZ
GENERAL TOLERANCE
ISO 2768 - M

UNBEMASSTE KANTEN
UNDIMENSIONED EDGES
x 45°
GEBROCHEN
CHAMFERED

LIEBH
Verzahn techn

hmotnost stroje: 10 t
Machine weight

c	Tschechische Texte anstatt deutsche Texte			30.04.08	MITO
b	ELB-Box hinzu			25.06.07	MITO
a	Gesamtanschlusswert wurde von 50kVA auf 31kVA geaendert			27.04.07	MITO
AENDERUNGEN MODIFICATIONS				DATUM DATE	NAME NAME
MASSTAB SCALE	GEZ. DRAWN	26.02.07	Miller	WERKSTOFF MATERIAL	NORM STD
1:20	GEPR. CHECKED	30.04.08	Miller	ROHMASSE ROUGH DIM	
BENENNUNG DESCRIPTION				ZEICHNUNGSNUMMER DRAWING NUMBER	
AUFSTELLPLAN LC300 MONTĚZNI VYKRES - INSTALLATION PLAN				56 12 328 02	
NTOLERANZ TOLERANCE	UNBEMASSTE KANTEN UNDIMENSIONED EDGES x 45° GEBROCHEN CHAMFERED			BLATT SHEET	1 VON 1 OF 1
768 - M	LIEBHERR Verzahrtechnik GmbH			FORMAT FORMAT	A1
				ENTSTANDEN AUS RESULTED FROM	561219002

THIS DRAWING MAY NOT BE COPIED OR DISCLOSED TO THIRD PARTIES WITHOUT THE WRITTEN PERMISSION OF THE DRAWING OFFICE
2006-04-24 ME10



FN 1650
LC300

FN 1704
LC300

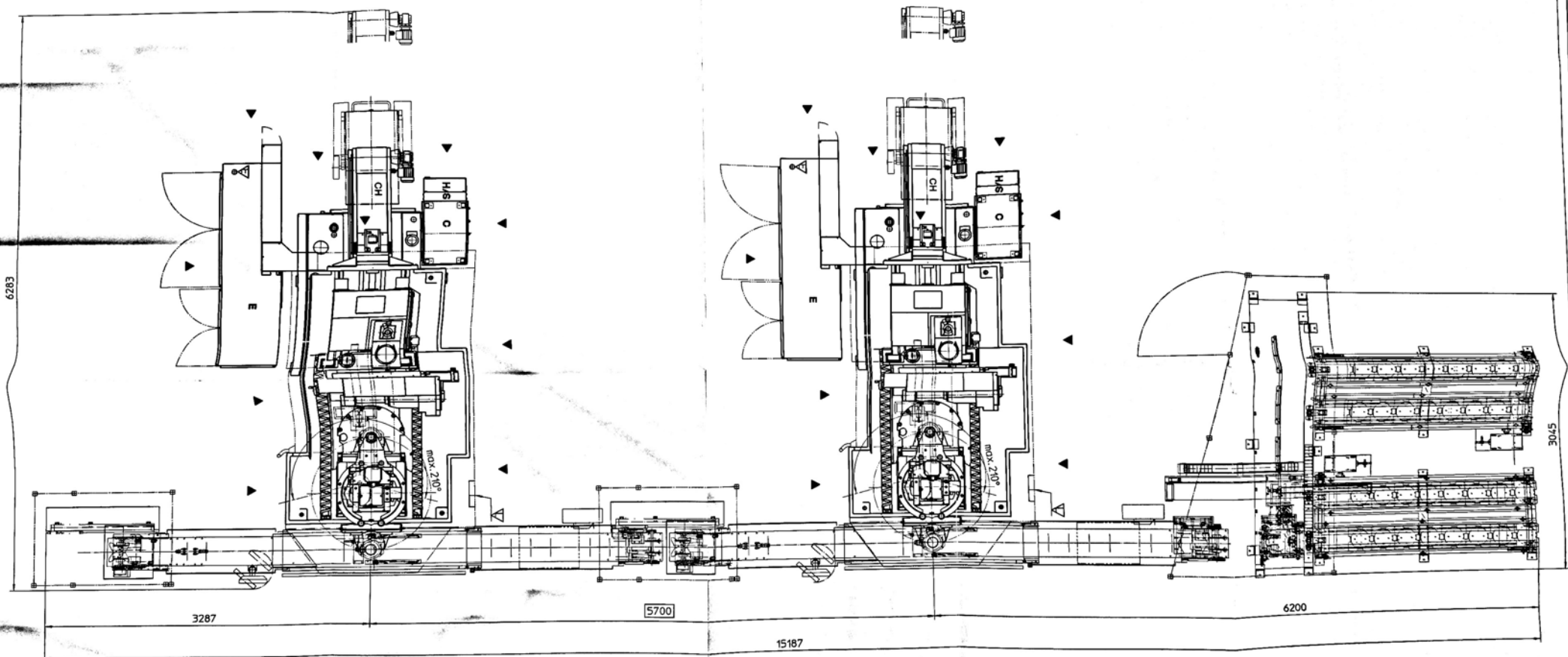

c) Seite Blatt 1		Blatt 02		Blatt 02	
d) Seite Blatt 1		Blatt 02		Blatt 02	
ANZEIGEN		STATUS		NAME	
DATE		DATE		NAME	
DATE	TIME	DATE	TIME	DATE	TIME
11.06.07	10:00	11.06.07	10:00	11.06.07	10:00
SCALE	SCALE	SCALE	SCALE	SCALE	SCALE
1:20	1:20	1:20	1:20	1:20	1:20
REVISIONS		REVISIONS		REVISIONS	
DESCRIPTION		DESCRIPTION		DESCRIPTION	
AUFSTELLPLAN LC300		AUFSTELLPLAN LC300		AUFSTELLPLAN LC300	
MONTAGE VIKRES - INSTALLATION PLAN		MONTAGE VIKRES - INSTALLATION PLAN		MONTAGE VIKRES - INSTALLATION PLAN	
DRAWING NUMBER		DRAWING NUMBER		DRAWING NUMBER	
56 12 328 02		56 12 328 02		56 12 328 02	
BLATT 2 VON 2		BLATT 2 VON 2		BLATT 2 VON 2	
SHEET 2 OF 2		SHEET 2 OF 2		SHEET 2 OF 2	
ENTSTANDEN AUS		ENTSTANDEN AUS		ENTSTANDEN AUS	
RESULTS FROM		RESULTS FROM		RESULTS FROM	
SAC/2002		SAC/2002		SAC/2002	

ALLE DIMENSIONEN
GENERAL DIMENSIONS
IN MM - IN

UNGENÜESSEN KANTEN
UNSHARPEN EDGES
+ 0,2

LIEBHERR
Verzahntechnik GmbH

VERVIelfältigung oder Weitergabe nur mit unserer schriftlichen Genehmigung gestattet

THIS DRAWING MAY NOT BE LOANED OR REPRODUCED TO ANY PARTIES WITHOUT THE WRITTEN PERMISSION

FN 1650
LC300

FN 1704
LC300

6283

3287

5700

15187

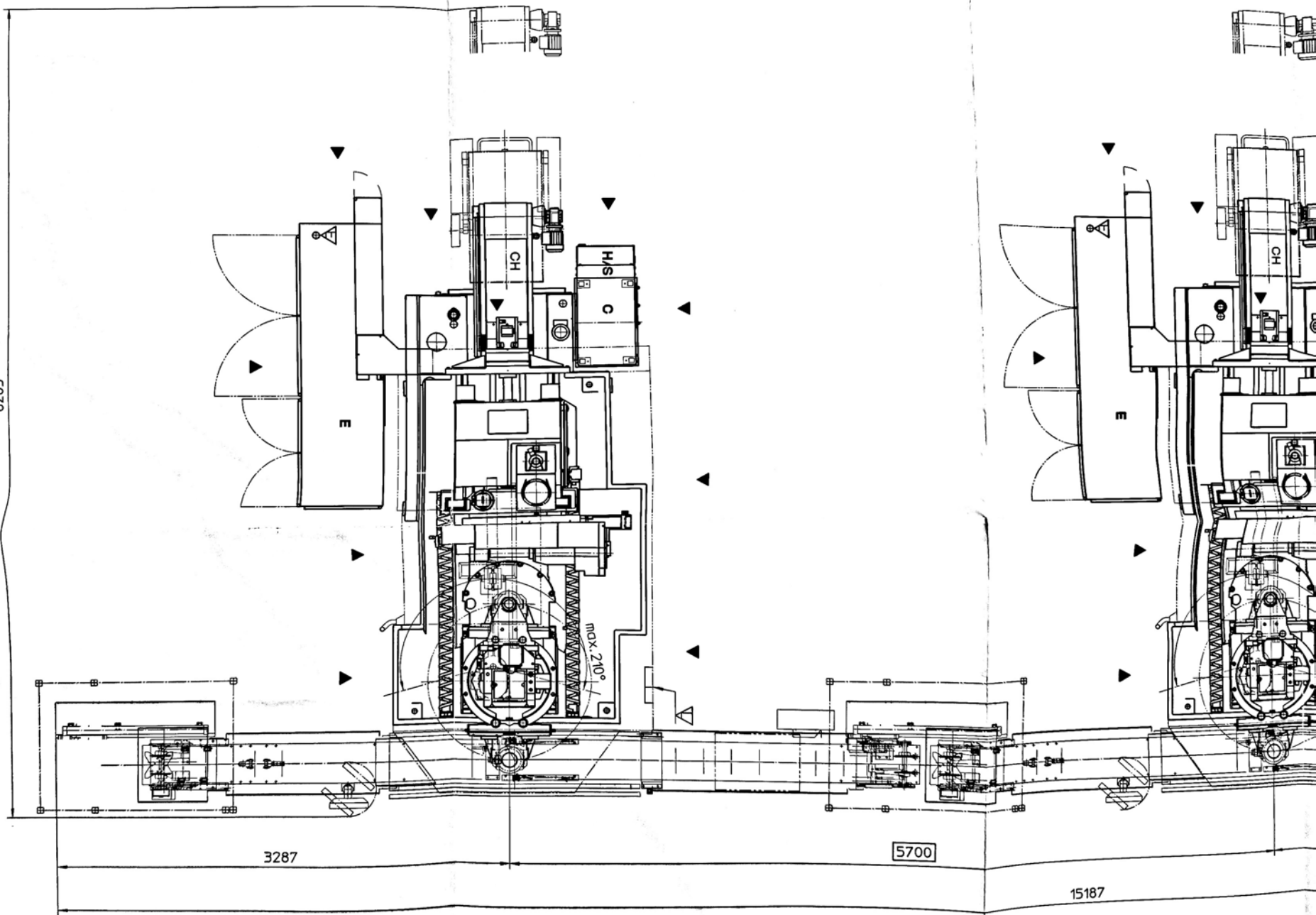

1650
300

FN 1704
LC300

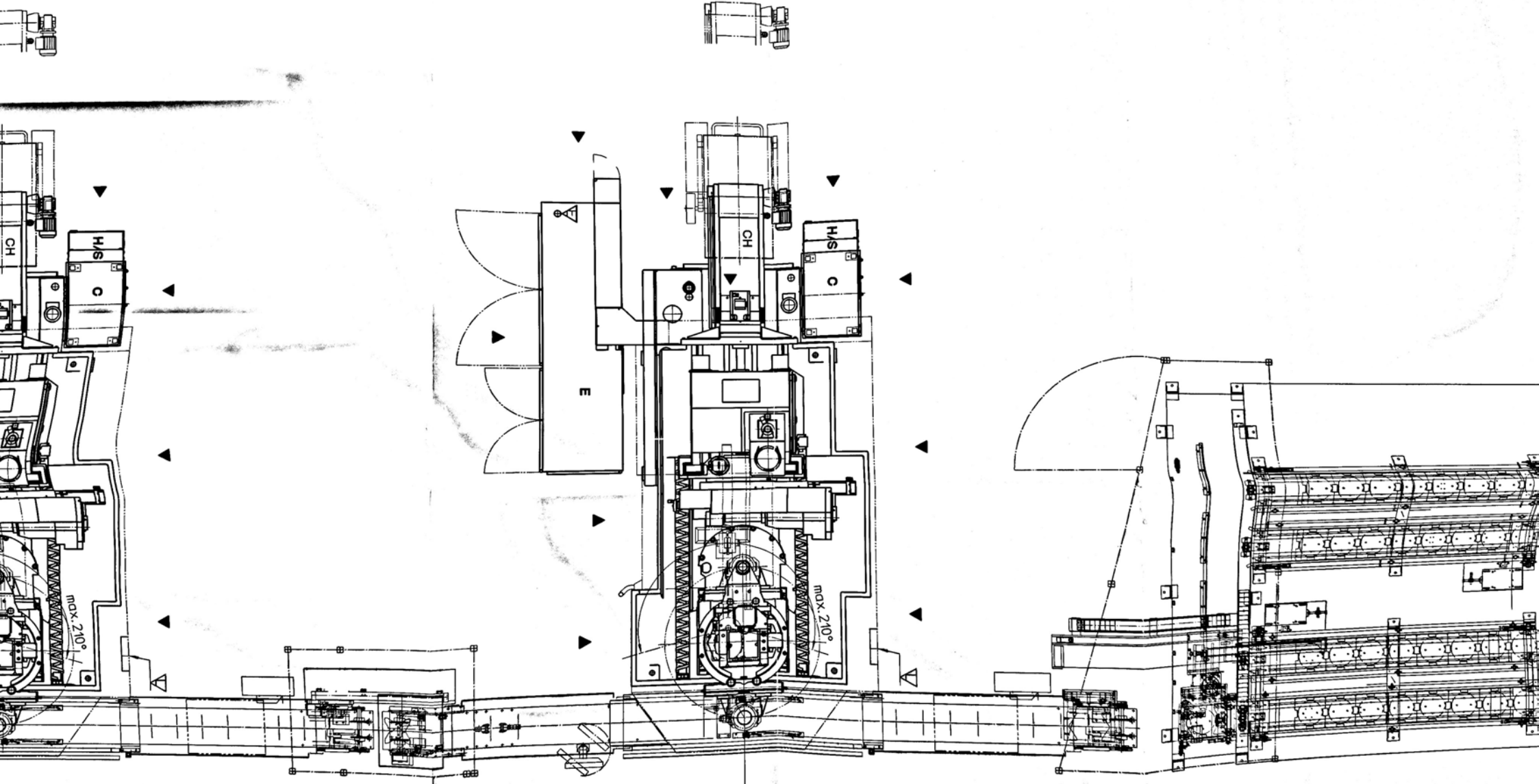

5700

15187

6200

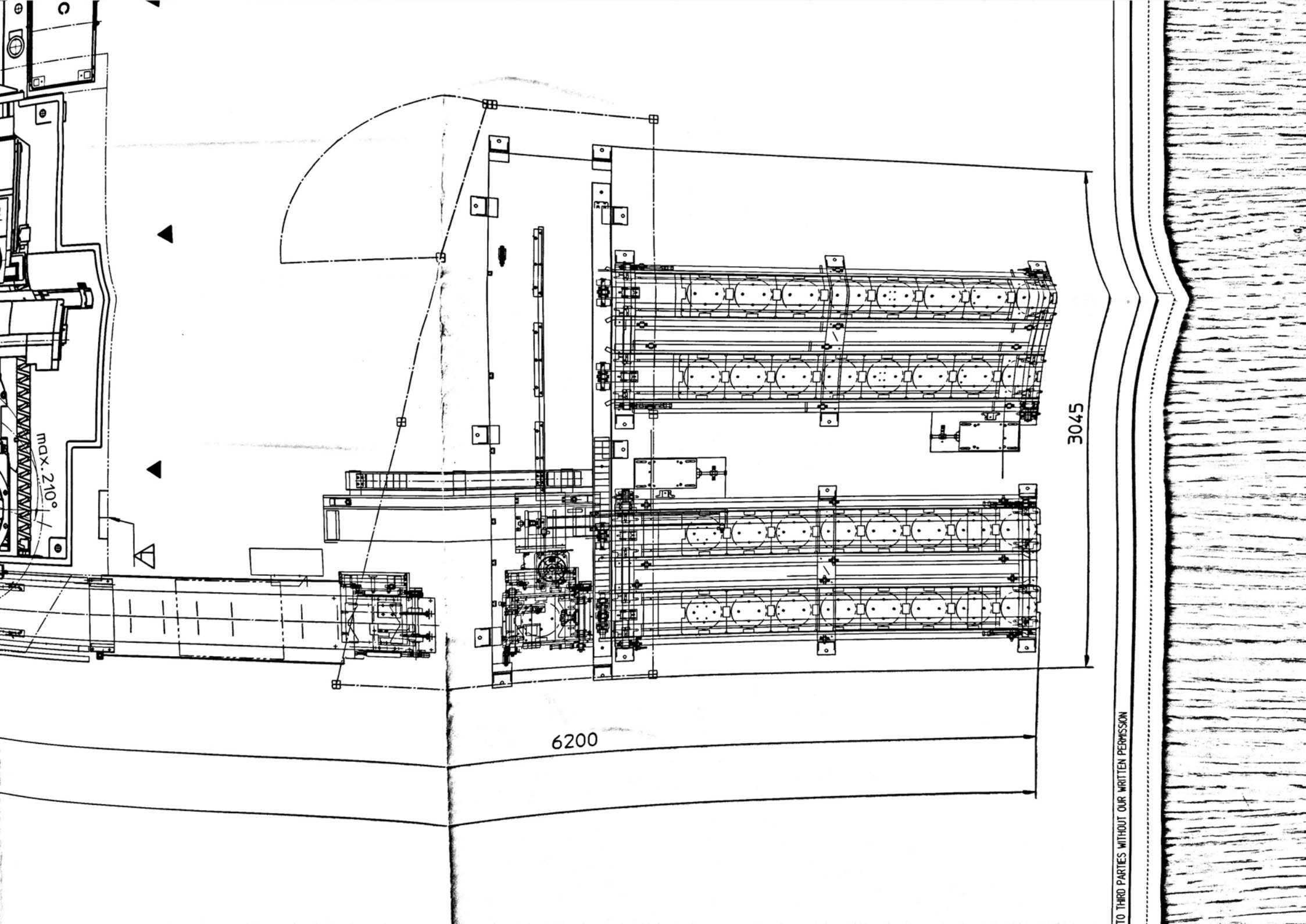

TO THIRD PARTIES WITHOUT OUR WRITTEN PERMISSION

THIS DRAWING MAY NOT BE COPIED OR DISCLOSED TO THIRD PARTIES
2006-04-24 ME10

c	Siehe Blatt 1				30.04.08	MT0
b	Siehe Blatt 1				23.08.07	MT0
ÄNDERUNGEN MODIFICATIONS					DATUM DATE	NAME NAME
MASSTAB SCALE	GEZ. DRAWN	11.06.07	Miller	WERKSTOFF MATERIAL	NORM STD	
	GEPR. CHECKED	30.04.08	Miller	ROHMASSE ROUGH DIM		
1:20				ROHMASSE ROUGH DIM		
BENENNUNG DESCRIPTION					ZEICHNUNGSNUMMER DRAWING NUMBER	
AUFSTELLPLAN LC300 MONTĀZNI VYKRES - INSTALLATION PLAN					56 12 328 02	
LIEBHERR Verzahntechnik GmbH				BLATT SHEET	2 VON OF 2	FORMAT FORMAT
				ENTSTANDEN AUS RESULTED FROM		561219002

ALLGEMEINTOLERANZ
GENERAL TOLERANCE
ISO 2768 - M

UNBEMASSTE KANTEN
UNDIMENSIONED EDGES
x 45°
GEBROCHEN
CHAMFERRED

ERNEUERUNG GESTATTET



1.3 Preparing for Commissioning

NOTE

For initial commissioning of the machine/installation we recommend, not only for warranty reasons, to enlist the Liebherr Customer Service.

General

Make sure that the customer will provide for all supplies necessary at the installation site:

- power
- compressed air
- central supply and disposal system

Removing Transport Locks

Make sure that all transport locks (normally red painted) are removed before commissioning the machine!

You will find the following transport locks:

- transport lock of the main column

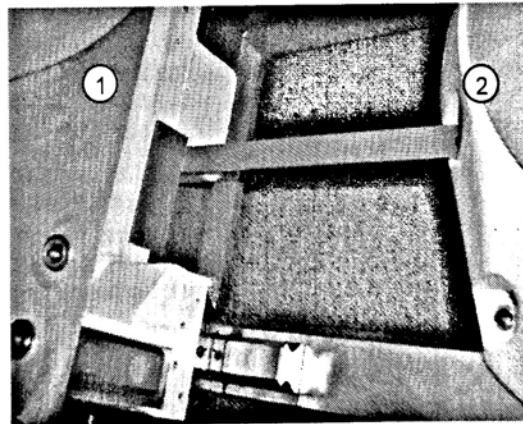

Figure 1 1 main column
2 worktable

- transport lock of the steady column

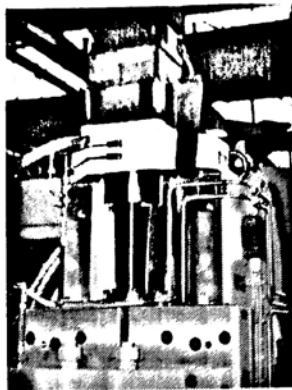



Figure 2

Removing Rust Protective Layer

 CAUTION	
Danger by cleaning agents!	
There is a danger of injury when using cleaning agents.	
Do not use caustic cleaning agents.	
Provide for good airing of the workshops.	
Wear protective gloves.	
Observe specifications of the cleaning agent manufacturers.	

Completely remove the rust-protective layer from all bare machine components such as guide ways, stop faces, mounting and clamping surfaces.

Appropriate agents: kerosene or cold cleaner.

Do not use waste wool, compressed air, emery paper, scrapers or similar for cleaning.

After cleaning thoroughly lubricate all bare parts using viscous oil.

Ancillary Equipment

Install and assembly the ancillary equipment.

See layout and respective operating instructions by the manufacturer.

Supply Lines for Ancillary Equipment

Set up connections and lines between the control cabinet and the ancillary equipment. Please refer to electric, hydraulic and pneumatic plans.

To avoid confusion and ensure correct identification, the tubes and lines and their respective connectors are bearing the same numbers and/or characters.

Oil Fillings**NOTE**

All oil outlets must be closed!

Fill all oil tanks with oil.

The filling volumes of the oil tanks, the location of the filler necks as well as the recommended oil types may be seen in the lubricating instructions in chapter "Service and Maintenance".

Electrical Connection**! DANGER**

The electric installation is generating high voltages dangerous for man. Physical contact with live components may cause serious injuries, and may even be fatal. Parts of the system may also be live with the main switch disabled. These parts are marked by colours; please see for this the circuit diagram.

Ancillary equipment is normally provided with a separate main switch. Make sure to check this without fail using the electrical documentation as well as directly „on site“ (please observe the notes).

Always set the main switch to Off when any work has to be carried out on the electrical system and secure it against being switched on.

Switch off the voltage supply to the machine when working on the main switch or on components that remain live after the main switch has been set to Off.

Only trained and skilled electricians may carry out work on the electric installation.

Transportation of the machine
1.3 Preparations for Commissioning

Lead-Ins, Fuses

The mains input and fusing have to be designed according to the specifications on the type plate of the control cabinet.

CAUTION

Even when under load, the actual supply voltage must not deviate from the rated voltage by more than the permissible tolerance.

- Check the mains input for safe insulation from supply.
- Insert the line through the corresponding opening of the control cabinet.
- Connect phases L1, L2 and L3 of the power supply cord to the terminals of the main switch.
- **Observe:** Make sure to correctly connect the phase sequence!
- Connect protective conductors to the corresponding bus bar.
- Check and re-tighten all devices and series terminals

**Switching the Machine
On**

⚠ DANGER

The electric installation is generating high voltages dangerous for man. Physical contact with live components may cause serious injuries, and may even be fatal. Parts of the system may also be live with the main switch disabled. These parts are marked by colours; please see for this the circuit diagram.

Ancillary equipment is normally provided with a separate main switch. Make sure to check this without fail using the electrical documentation as well as directly „on site“ (please observe the notes).

Bare terminals and insulation errors may cause burns or death by electric shock.

Before switching on the fuses, secure all live components using the corresponding covers and close all doors of the control cabinet.

Close all safeguards and servicing doors.

Only trained and skilled electricians may carry out work on the electric installation.

**Setting the Main Switch to
On**

- Switch on the control voltage. Now all ancillary units are operational, i.e. motors on pumps.
- Check the rotating field using an appropriate measuring device.

Aligning the Machine

NOTE

Correct installation and, especially, precise aligning of the machine/equipment are prerequisites for satisfactory production results. The type of installation and attachment of the machine and the arrangement of the ancillary equipment and units are shown in the layout.

Tools

In order to align the machine, the following tools are required:

- various wrenches.
- box-type spirit level

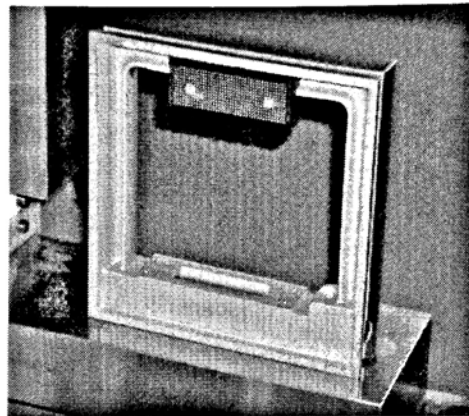

Figure 3

Anchored Installation

With the levelling bolts backed off, tighten all attaching bolts and nuts uniformly.

**Small-Sized Machines
(LC 80 – LC 180)**

For these machines, aligning is measured on the worktable. To this end, remove the clamping fixture

- Place box-type spirit level lengthwise (A) and crosswise (B) on the work table as shown below.

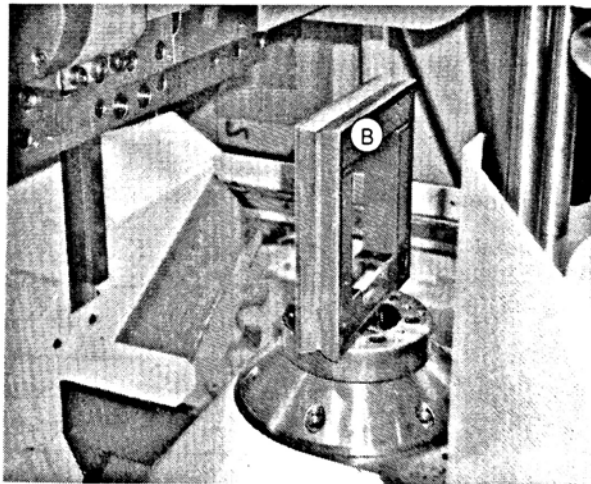
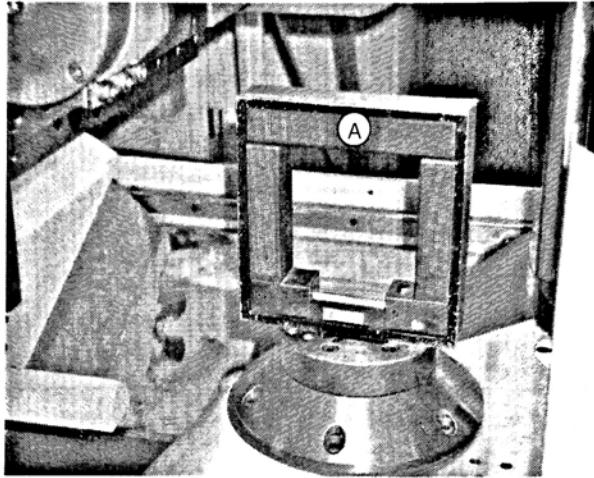

Figure 4

Deviation in all measurements must be less than 0.02. mm. If this value is exceeded, slacken the corresponding attaching bolts and nuts slightly and adjust at the levelling bolts. Repeat this procedure until the aforementioned requirement is met.

**Large-Sized Machines
(LC 200 – LC 380)**

- Place box-type spirit level lengthwise (A) and crosswise (B) on the machine bed flat guides as shown below.

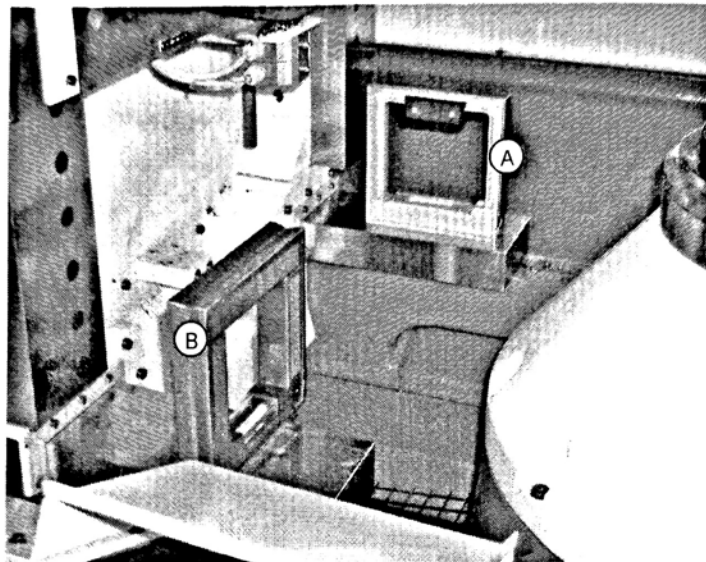

Figure 5

- Deviation in all four measurements must be less than 0.02 mm. If this value is exceeded, slacken the corresponding attaching bolts and nuts slightly and adjust at the levelling bolts. Repeat this procedure until the aforementioned requirement is met.

**Floating Installation on
Levelling Elements**

Measure as described for „Anchored Installation“ and, if required, adjust at the levelling elements.

NOTE

Ensure that the levelling bolts as well as the levelling elements are loaded uniformly.

**Checking Machine
Geometry**

Machine geometry has been measured upon manufacturing of the machine in the plant of the manufacturer.

NOTE

The machine must be at normal operating temperature.

The machine must be in aligned condition.

Tools

- Dial gauges with 0.001 mm division and tracer pin with a crowned feeler face.
- Magnetic dial gauge holder
- Cylindrical measuring arbour with a length > L4 and L1.
L4 = axial travel of cutter slide (see Technical Data).
L1 = axial travel of tailstock slide (see Technical Data)

NOTE

Measuring arbors are not in the standard scope of delivery of the machine. You may order them from Liebherr.

2

3

4

5

6

7

3

9

0

Aligning the Machine Column

- Move machine column (X1-axis) to the extreme backward position.
- Attach dial gauges by means of the magnetic holders to the cutter slide.
- Attach measuring arbor on the worktable and approximately align it by hand.
- Place dial gauges as shown in the picture and let the main drive turn at a low speed. Center measuring arbor in radial run-out in both measuring directions. Measure at A and B throughout the whole axial travel L_4 .

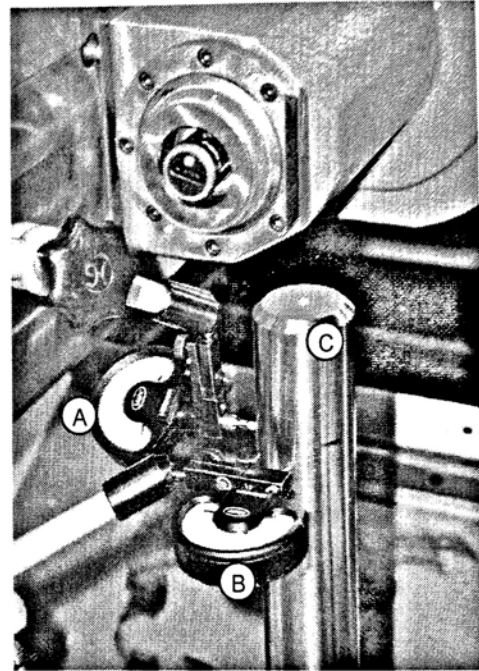
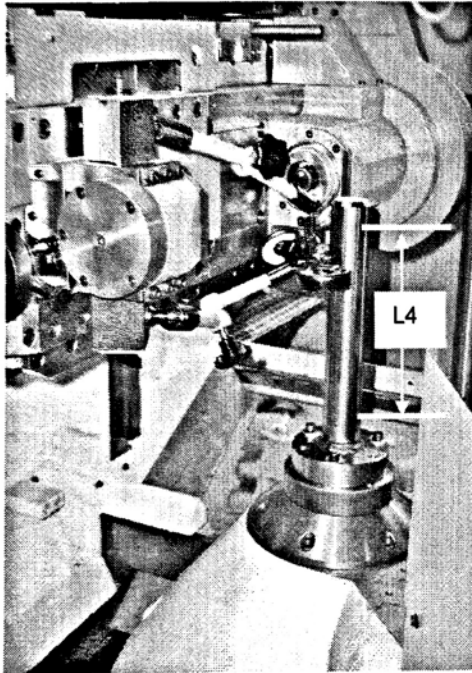

Figure 6

Permissible deviations:

At A:

Hobbing machines	Grinding machines
$8 + 0,8 * \sqrt{L_4}$	$1 + 0,6 * \sqrt{L_4}$

- It must be added that deviation is only permissible at the free end of the measuring arbor (C) towards the axis of the workpiece support.

At B:

Hobbing machines	Grinding machines
$6 + 0,5 * \sqrt{L_4}$	$\frac{2 * (1 + 6 * \sqrt{L_4})}{3}$

If these deviations are exceeded, re-alignment of the machine is required as described above.

Aligning the Tailstock

- Attach dial gauges with magnetic holders to the tailstock arm.
- Place dial gauges against the measuring arbor as shown in the picture. Center measuring arbor in radial run out in every measuring direction. Measure at A and B throughout the whole axial travel L_1 of the tailstock arm, in both shifting directions.

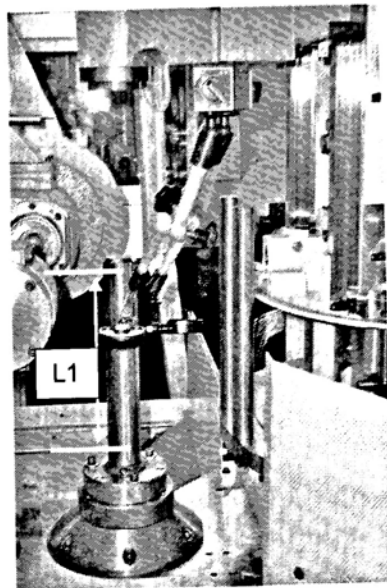
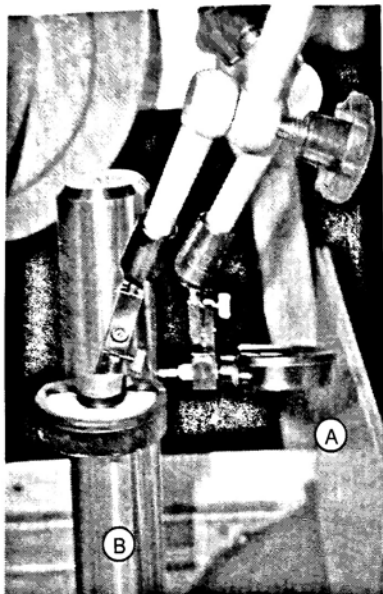

Figure 7

Permissible deviations:

At A:

Hobbing machine	Grinding machine
$8 + 0,8 * \sqrt{L_1}$	$1 + 0,6 * \sqrt{L_1}$

- It must be added that the whole deviation is only permissible at the free end of the measuring arbor towards the axis of the workpiece support. In opposite direction, only half of the deviation is permissible.

At B:

Hobbing machine	Grinding machine
$6 + 0,5 * \sqrt{L_1}$	$\frac{2 * (1 + 0,6 * \sqrt{L_1})}{3}$

If these deviation limits are exceeded, re-alignment of the machine is required as described above.

Measuring Radial Run-Out of Mounting Hole on Main and Counter-Bearing

In order to measure radial run-out two methods are applicable:

- Radial run-out without counter-bearing
- Radial run-out with clamped counter-bearing

Measuring Radial Run-Out without Counter-Bearing

- Move counter-bearing back.
- Clamp measuring arbor in the main bearing
- Place dial gauge against the measuring arbor (see figure 8).
- Switch on B1-axis at low speed and gauge radial run-out.

Deviation must not exceed 5 μm .

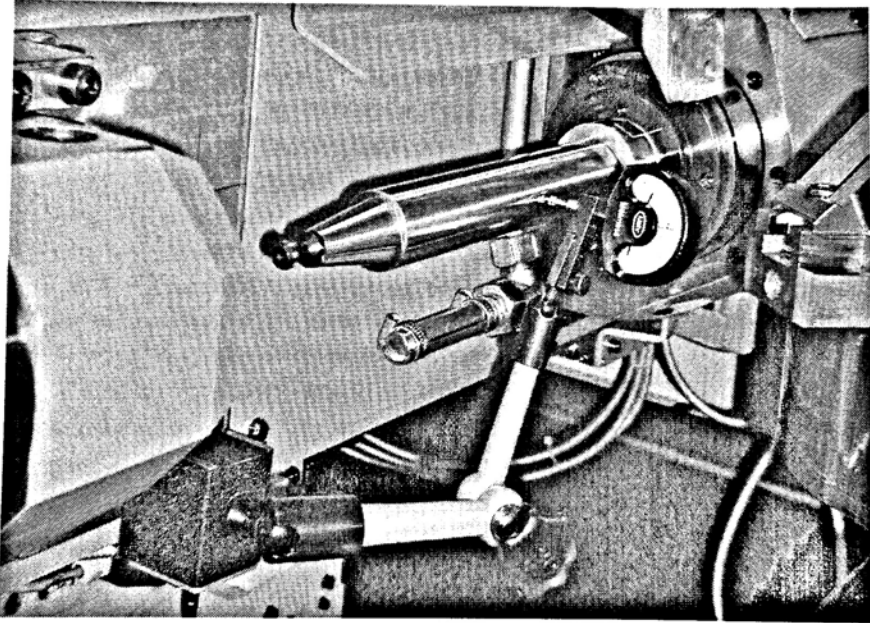

Figure 8 Measuring radial run-out, self-supporting

Measuring Radial Run-Out
with Clamped Counter-
Bearing

- Clamp measuring arbor in main and counter-bearing
- Place dial gauges against the measuring arbor (see figure 9)
- Switch on B1-axis at low speed and gauge radial run-out.

Deviation must not exceed 3 μm .

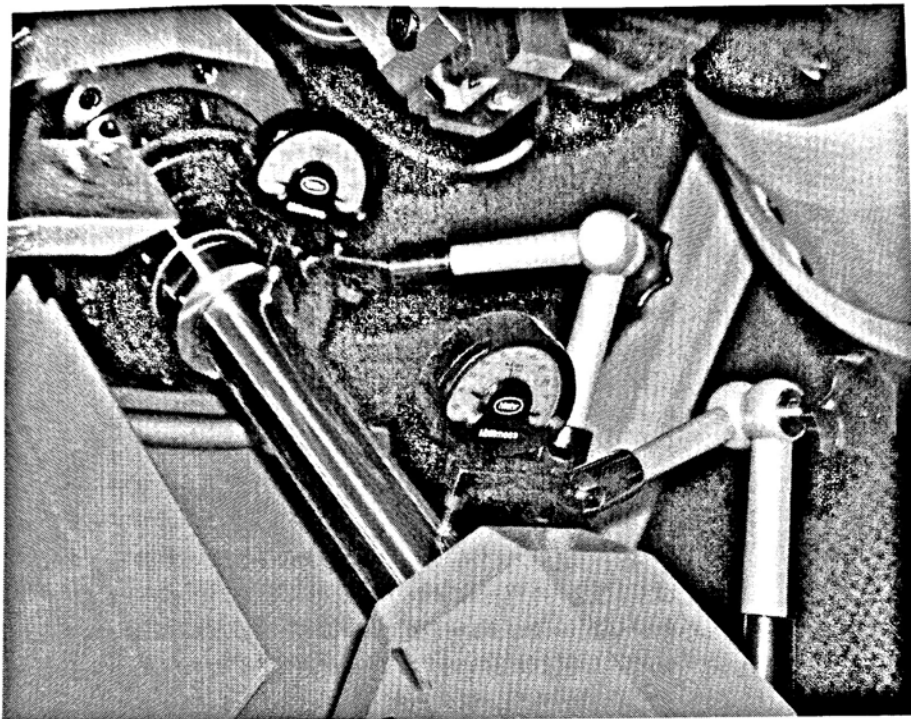

Figure 9 Measuring radial run-out with clamped main and counter-bearing

Checking Parallelism of
Master Workpiece in a and b
Direction

Measuring Arbor Clamped in
Main Bearing, without
Counter-Bearing

Deviation is determined in 3 ways:

- Measuring arbor clamped in main bearing, without counter-bearing
 - Measuring arbor clamped in main bearing, with counter-bearing approached but not clamped.
 - Measuring arbor clamped in main and counter-bearing.
-
- Move counter-bearing back
 - Mount measuring arbor
 - Place dial gauges against the measuring arbor (see figure 10)
 - Gauge measuring arbor in direction of the counter-bearing using the V1-axis

The permissible deviation depends on the formula below:

Hobbing machines	Grinding machines
$6 + 0,5 \cdot \sqrt{L_7}$	$3 + 0,4 \cdot \sqrt{L_7}$

Example:

On the LCS 280 machine, having a cylinder base of 230mm, maximum permissible deviation must not exceed 9µm.

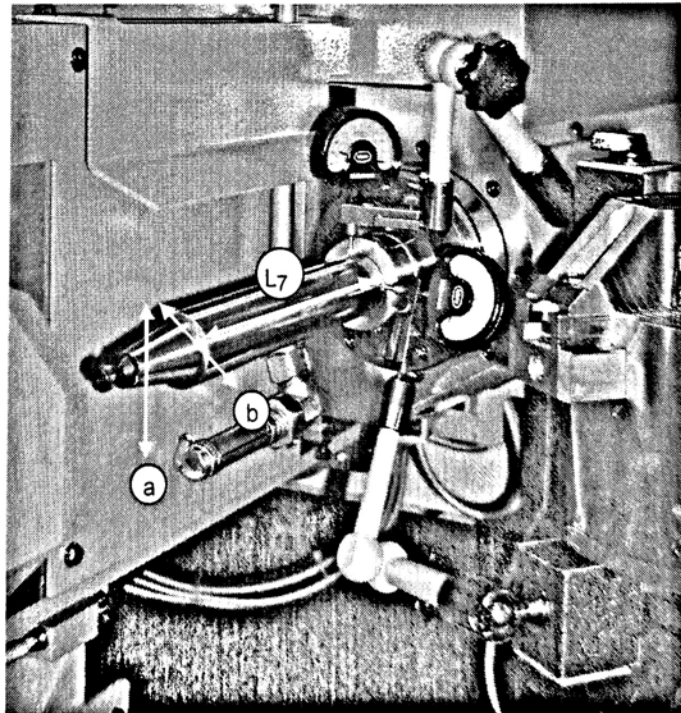

Figure 10 Measuring arbor clamped in the main bearing, without counter-bearing

Clamping Measuring Arbor in
the Main Bearing with the
Counter-Bearing Approached
but not Clamped

- Clamp measuring arbor in the main bearing
- Approach counter-bearing but do not clamp
- Place dial gauges against the measuring arbor (see figure 11)
- Gauge measuring arbor in direction of the counter-bearing using the V1-axis

The permissible deviation depends on the formula below:

Hobbing machines	Grinding machines
$6 + 0,5 \cdot \sqrt{L_7}$	$3 + 0,4 \cdot \sqrt{L_7}$

Example:

On a LCS 280 machine having a cylinder base of 230mm, maximum permissible deviation must not exceed 9µm.

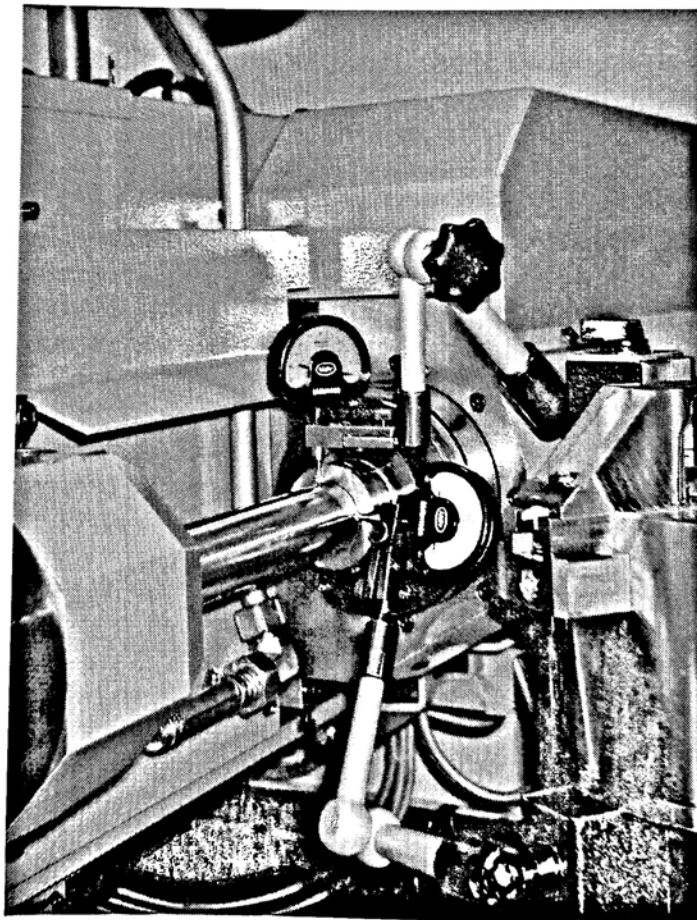

Figure 11 Clamp measuring arbor in the main bearing with the counter-bearing approached but not clamped

**Measuring Arbor Clamped in
Main Bearing and Counter-
Bearing**

- Clamp measuring arbor in the main and counter-bearing
- Place dial gauges against the measuring arbor at the right (measuring point 1).
- Start B1-axis at low speed.
- Gauge measuring arbor in direction of the counter-bearing using the V1-axis.



Figure 12 measuring point 1



Figure 13 measuring point 2

Test Run

Generally, in an internal final acceptance test before delivery of the machine, original customer workpieces (acceptance workpieces) are manufactured under the future production conditions. That means that the machine will arrive at the customer's site in a workpiece-specific setting condition. If the machine will not be started up with the same workpiece, the set-up of the machine must of course be adapted and set to the new workpiece condition.

CAUTION

We recommend to perform the first machining cycle without tool and at reduced speed of axes. While doing this, always be aware of possible collisions.

After this, cut a workpiece in automatic mode under production conditions and check it for the required quality.

2.0 Technical Data of Machine

Hobbing machine		LC 300
	Max. workpiece diameter	300 mm
	Table diameter	250 mm
	Max. table speed	100 1/min
	Center distance	15 ... 400 mm
	Total weight approx.	15000 kg
	Ambient temperature	12 ... 45°C
	Relative air humidity	90% max. at 20°C 50% max at 40°C
Machine column		
	Max. axial travel	600 mm
Cutter head swivelling device		
	Cutter head swivelling angle	+/- 45 degrees
Cutter head		
	Power	14 kW
	Max. module	7 mm
	Max. cutter speed	750 1/min
	Max. cutter diameter	160 mm
	Max. cutter length	230 mm
	Max. tangential travel	200 mm
	Max. tangential speed	3000 mm/min
	Smallest teeth number to be cut	4

2.0 Technical Data of Machine

Operating and control voltage		
	Operating voltage (tolerance +/- 10%)	400 V
	Operating frequency (tolerance +/- 2%)	50 Hz
	Control voltage	24 V DC
Hydraulics		
	Hydraulic oil	HLP 46
	Max. operating pressure	70 bar
	Pump delivery	24 l/min
	Hydraulic oil volume in hydraulic reservoir ca.	100 l
Wet-cutting device		
	Max. average noise level	80 dB(A)
Coolant system: Cooling oil		
	Coolant quantity in machine bed	780 l
	Flow at nozzle max.	100 l/min
Tailstock		
	Max. travel of tailstock	540 mm
	Max. speed of tailstock	15000 mm/min

2.1 Calculating the Table Speed

During workpiece machining the controller calculates the appropriate table speed depending on the number of starts of tool and the number of teeth on the workpiece. If the maximum table speed is exceeded, an error message is displayed on the screen of the control panel.

In order to avoid exceeding the maximum permissible speed of the work-table (see Technical Data), the table speed may be calculated based on the following formulas.

You may calculate the current table speed using the following formula:

n_t = table speed

n_f = spindle speed

Z_0 = number of starts of tool

Z_2 = number of teeth on workpiece

$$n_t = \frac{z_0 \cdot n_f}{z_2}$$

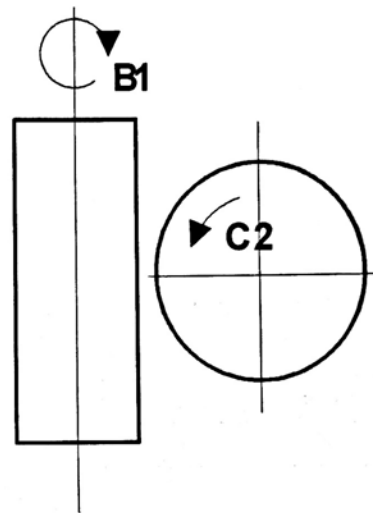

With the EGB closed, ADDITIONNAL ROTARY MOTION may occur and influence the above calculated table speed.

We distinguish two additional movements:

Tangential-differential portion, caused by the V1-axis motion

$$n_t = \frac{z_0 \cdot n_f}{z_2} \pm \frac{2 \cdot z_0 \cdot v_V}{P_{z0} \cdot z_2}$$

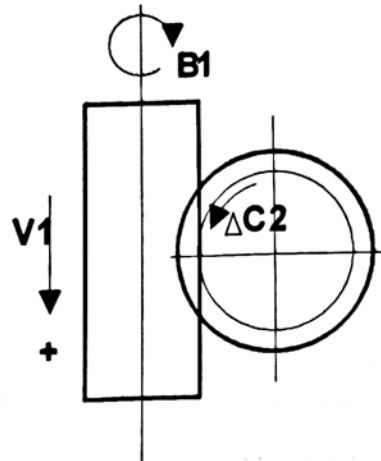

Axial-differential portion, caused by the Z1-axis motion

$$n_t = \frac{z_0 \cdot n_f}{z_2} \pm \frac{2 \cdot \sin \beta_2 \cdot v_z}{z_2 \cdot m_n \cdot \pi}$$

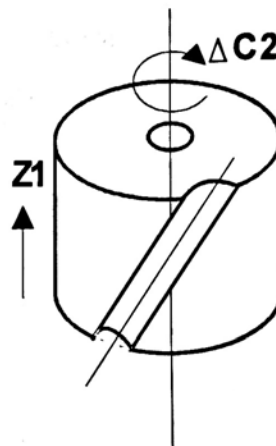

Both portions may have a SUBSTRACTING or an ADDING effect on the table speed depending on the direction of traverse.

If during machining both portions occur simultaneously, you may use the following formula to calculate the total table speed:

$$n_t = \frac{z_0 \cdot n_f}{z_2} \pm \frac{2 \cdot \sin \beta_2 \cdot v_z}{z_2 \cdot m_n \cdot \pi} \pm \frac{2 \cdot z_0 \cdot v_V}{P_{z0} \cdot z_2}$$

- β_2 = helix angle on workpiece in degrees
- m_n = normal module in mm
- z_0 = lead on tool in mm
- v_V = max. speed of V-axis in mm/mm
- v_z = max. speed of Z-axis in mm/mm

3.0 Axis LC

Identification of the axes

The machine axes are identified by defined names which are a combination of a letter and an index number.

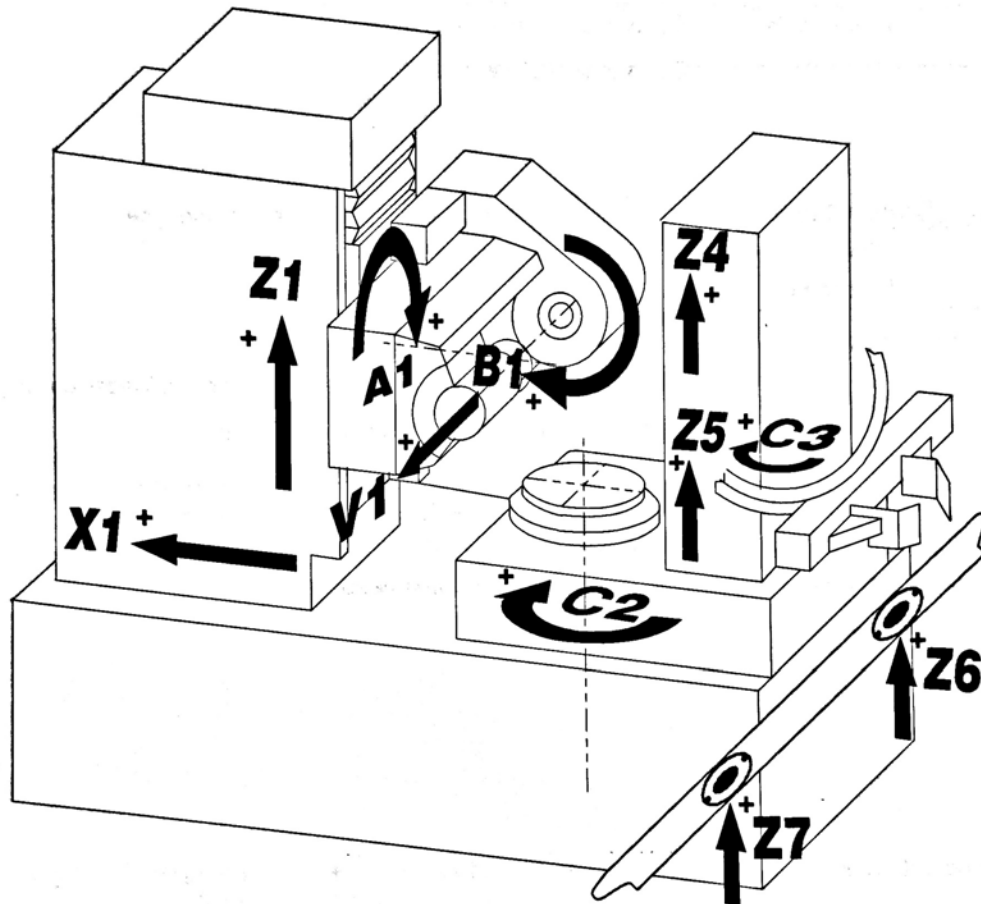

Standard axes	Every hobbing machine is provided with the following axes:
Linear axis	X1-axis: radial axis of cutting head Z1-axis: axial axis of the cutting head V1-axis: tangential axis: tool
Rotary axis	B1-axis: tool axis - main drive C2-axis: workpiece axis
Optional axis	These axes depend on the machine design and type.
Linear axis	Z4-axis: motion of tailstock arm Z5-axis: workpiece-pocket-lowering Z6-axis: NC-lifting station (workpiece transfer ring loader-conveyor) Z7-axis: NC-lifting station (centrifugal station)
Rotary axis	C3-axis: ring loader rotary motion
Cutter head swivel axis	A1-axis: swivelling of cutter head